

Technics®

Minidisc Deck

Operating Instructions

Model No. **SJ-MD150**

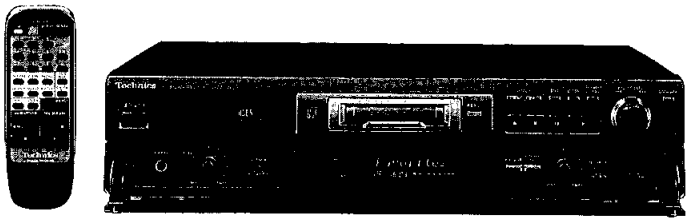

EB

Note:
The "EB" indication shown on the packing case indicates United Kingdom.

Before connecting, operating or adjusting this product, please read these instructions completely. Please keep this manual for future reference.

RQT5411-B

Dear Customer

Thank you for purchasing this Technics product. For optimum performance and safety, please read these instructions carefully.

Before use

Table of contents

Before use

- Accessories..... 2
- Caution for AC Mains Lead..... 3
- Suggestions for safety 4
- Connections 5
- Front panel controls 6
- The remote control 7

Recording and Listening operations

- Basic recording operations 8
- Basic playback operations 10
- Functions to assist recording 11
 - Synchronized recording 11
 - Adding track marks during recording 11
- Other playback modes 12
 - Direct play 12
 - Random play 12
 - Program play 13
 - Repeat play 14
- Convenient functions 15
 - Changing the display 15
 - Scrolling the display 15
 - Using headphones 15
 - Monitor function..... 15

Editing MDs/Timer

- Editing MDs 16
 - Titling tracks and discs..... 16
 - Dividing tracks - DIVIDE..... 19
 - Moving tracks - MOVE 20
 - Combining tracks - COMBINE 21
 - Erasing tracks 22
 - Erasing an entire MD 22
- Timer recording and playback..... 23
 - Timer recording 23
 - Timer playback..... 23

Additional information

- Error messages..... 24
- Troubleshooting guide 25
- MDs 26
- Maintenance 26
- Technical specifications 27

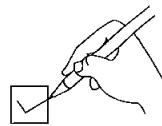

Please check and identify the supplied accessories.

- AC mains lead 1

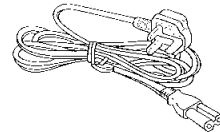

(RJA0044-3C)

- Stereo phono cables 2

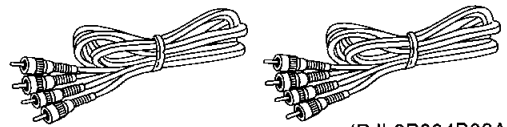

(RJL2P004B08A)

- Optical-fiber cable 1

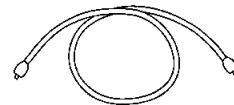

(RJL1X007B08)

- Remote control transmitter 1

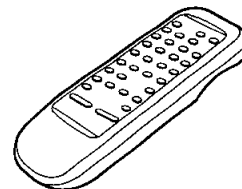

(EUR645272)

- Batteries 2

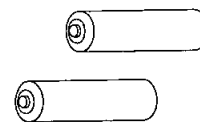

Use numbers indicated in parentheses when asking for replacement parts.

Note

The included AC mains lead is for use with this unit only. Do not use it with other equipment.

Caution for AC Mains Lead



(For United Kingdom)
("EB" area code model only)

For your safety, please read the following text carefully.

This appliance is supplied with a moulded three pin mains plug for your safety and convenience.

A 5-ampere fuse is fitted in this plug.

Should the fuse need to be replaced please ensure that the replacement fuse has a rating of 5-ampere and that it is approved by ASTA or BSI to BS1362.

Check for the ASTA mark  or the BSI mark  on the body of the fuse.

If the plug contains a removable fuse cover you must ensure that it is refitted when the fuse is replaced.

If you lose the fuse cover the plug must not be used until a replacement cover is obtained.

A replacement fuse cover can be purchased from your local dealer.

CAUTION!

IF THE FITTED MOULDED PLUG IS UNSUITABLE FOR THE SOCKET OUTLET IN YOUR HOME THEN THE FUSE SHOULD BE REMOVED AND THE PLUG CUT OFF AND DISPOSED OF SAFELY.

THERE IS A DANGER OF SEVERE ELECTRICAL SHOCK IF THE CUT OFF PLUG IS INSERTED INTO ANY 13-AMPERE SOCKET.

If a new plug is to be fitted please observe the wiring code as stated below.

If in any doubt please consult a qualified electrician.

IMPORTANT

The wires in this mains lead are coloured in accordance with the following code:

Blue: Neutral, Brown: Live.

As these colours may not correspond with the coloured markings identifying the terminals in your plug, proceed as follows:

The wire which is coloured Blue must be connected to the terminal which is marked with the letter N or coloured Black or Blue.

The wire which is coloured Brown must be connected to the terminal which is marked with the letter L or coloured Brown or Red.

WARNING: DO NOT CONNECT EITHER WIRE TO THE EARTH TERMINAL WHICH IS MARKED WITH THE LETTER E, BY THE EARTH SYMBOL \perp OR COLOURED GREEN OR GREEN/YELLOW.

THIS PLUG IS NOT WATERPROOF—KEEP DRY.

Before use

Remove the connector cover.

How to replace the fuse

The location of the fuse differ according to the type of AC mains plug (figures A and B). Confirm the AC mains plug fitted and follow the instructions below.

Illustrations may differ from actual AC mains plug.

1. Open the fuse cover with a screwdriver.

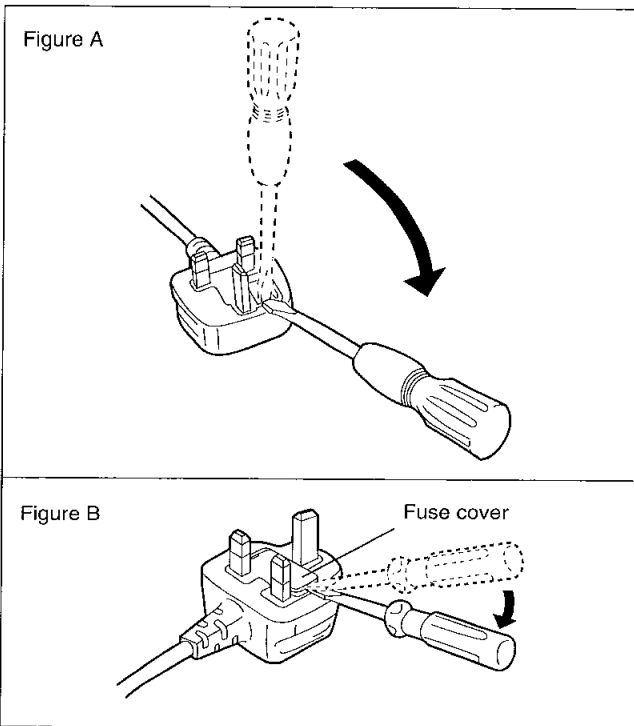

2. Replace the fuse and close or attach the fuse cover.

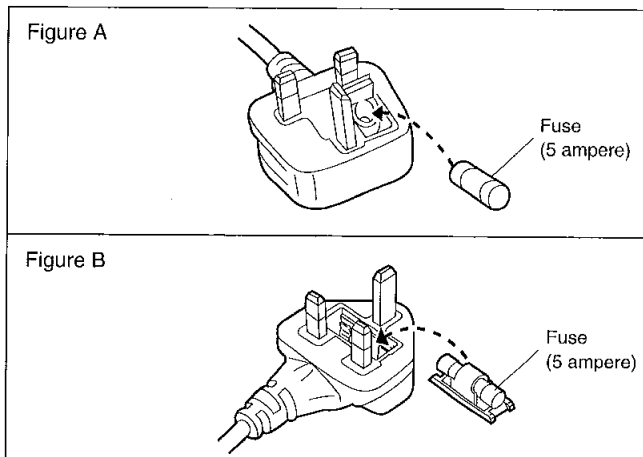

Before use

**CLASS 1
LASER PRODUCT**

(Back of product)

DANGER	INVISIBLE LASER RADIATION WHEN OPEN. AVOID DIRECT EXPOSURE TO BEAM.	(Inside of product)
ADVARSEL	USYNLIG LASERSTRÅLING VED ÅBNING. NÅR SIKKERHEDSÅFBRYDERE ER LØDE AF FUNKTION. UNDGÅ UDSÆTTELSE FOR STRÅLING.	(Indersiden af apparatet)
VARO!	AVATTAESSA JA SUOJALUKITUS OHITETTAESSA OLET ALLTTIINA NÄKYMÄTÖNTÄ LASERSÄTELYLLE. ÄLÄ KATSO SÄTEESEEN.	(Tuotteen sisällä)
VARNING	OSYNLIG LASERSTRÅLING NÅR DENNA DEL ÄR ÖPPNAD OCH SPÅRÄN ÄR URKOPPLAD. BETRÄKTA EJ STRÅLEN.	(Apparatens insida)
ADVARSEL	USYNLIG LASERSTRÅLING NÅR DEKSEL ÅPNES OG SIKKERHEDSLÅS BRYTES. UNNGÅ EKSPONERING FOR STRÅLEN.	(Produktets innside)
VORSICHT	UNSIICHTBARE LASERSTRÄHLUNG, WENN ABDECKUNG GEÖFFNET. NICHT DEM STRAHL AUSSETZEN.	(Im Inneren des Gerätes)

CAUTION!

THIS PRODUCT UTILIZES A LASER. USE OF CONTROLS OR ADJUSTMENTS OR PERFORMANCE OF PROCEDURES OTHER THAN THOSE SPECIFIED HEREIN MAY RESULT IN HAZARDOUS RADIATION EXPOSURE. DO NOT OPEN COVERS AND DO NOT REPAIR YOURSELF. REFER SERVICING TO QUALIFIED PERSONNEL.

CAUTION!

DO NOT INSTALL OR PLACE THIS UNIT IN A BOOKCASE, BUILT IN CABINET OR IN ANOTHER CONFINED SPACE. ENSURE THE UNIT IS WELL VENTILATED. ENSURE THAT CURTAINS AND ANY OTHER MATERIALS DO NOT OBSTRUCT THE VENTILATION TO PREVENT RISK OF ELECTRIC SHOCK OR FIRE HAZARD DUE TO OVERHEATING.

Placement

Avoid placing the unit in areas of:

- direct sunlight
- high temperature
- high humidity
- excessive vibration
- uneven surfaces (Place the unit on a flat level surface.)

Such conditions might damage the cabinet and/or other component parts and thereby shorten the unit's service life.

Stacking

Never place heavy items on top of the unit or the AC mains lead.

Voltage

- It is very dangerous to use an AC power source of high voltage such as for an air conditioner.
A fire might be caused by such a connection.
- A DC power source can not be used.
Be sure to check the power source carefully, especially if on a ship or other place where DC is used.

AC mains lead protection

- Avoid cuts, scratches or poor connection of the AC mains lead, as this may result in fire or electric shock.
Excessive bending, pulling or slicing of the AC mains lead should also be avoided.
- Do not pull on the AC mains lead when you are disconnecting the power, as this could cause an electric shock. Grasp the plug firmly when you disconnect the AC mains lead.
- Never touch the plug with wet hands or a serious electric shock could result.

Foreign materials

- Ensure that no foreign objects, such as needles, coins, screwdrivers etc., accidentally fall into the unit.
Otherwise, a serious electric shock or malfunction could occur.
- Be extremely careful about spilling water or liquid on/into the unit, as a fire or electric shock could occur.
(Disconnect the power plug and contact your dealer immediately if this occurs.)
- Avoid spraying insecticides onto the unit as they contain flammable gases which can be ignited.
- Insecticides, alcohol, paint thinner and similar chemicals should never be used to clean the unit as they can cause flaking or cloudiness to the cabinet finish.

Service

- Never attempt to repair, disassemble or reconstruct the unit if there seems to be a problem.
A serious electric shock could result if you ignore this precautionary measure.
- If a problem occurs during operation (the sound is interrupted, indicators fail to light up, smoke is detected, etc.) contact your dealer or Authorized Service Center immediately.
- Disconnect the AC mains lead if the unit will not be used for a long time. Otherwise the operation life could be shortened.

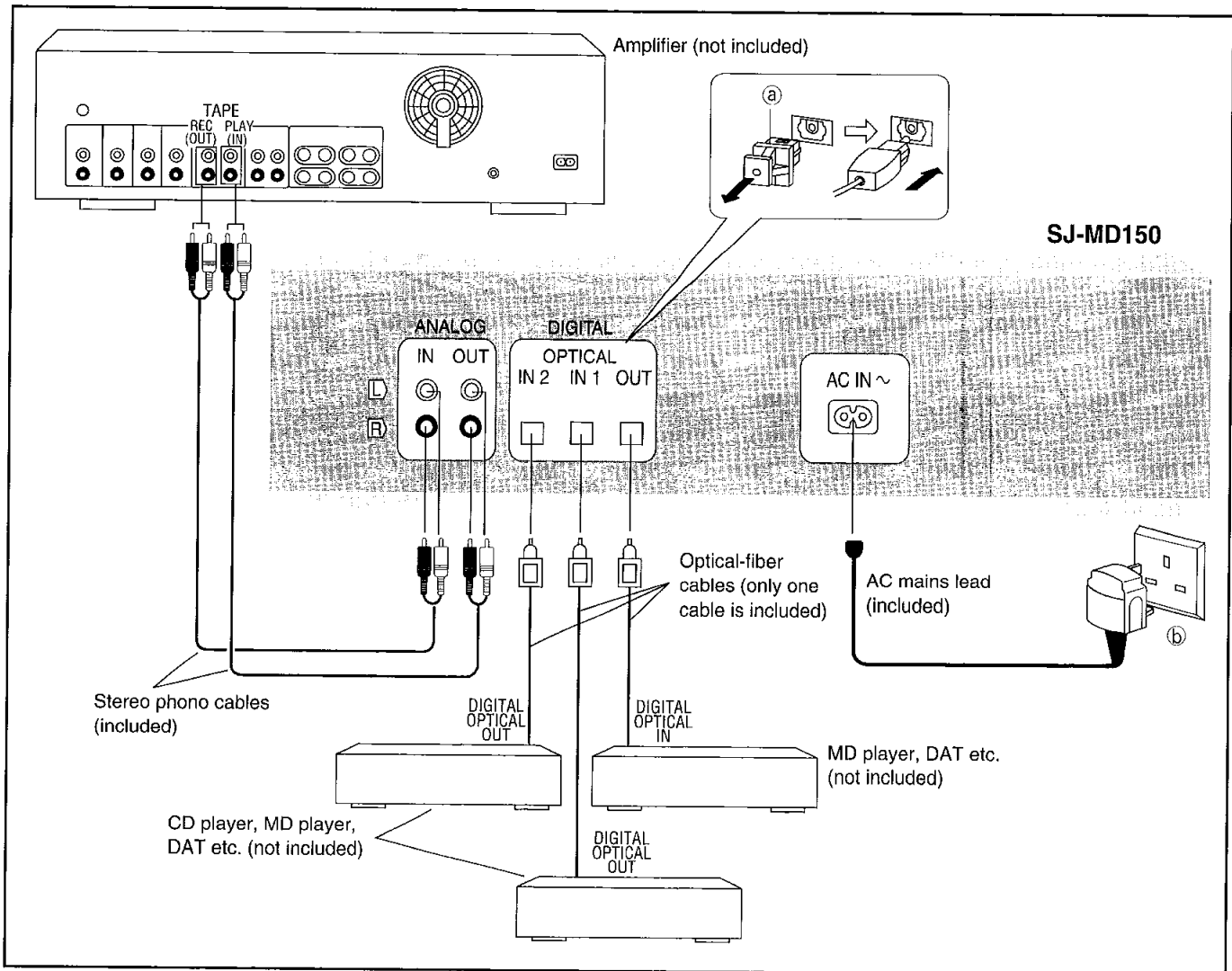

Before use

This example shows the unit connected to an amplifier through the ANALOG IN/OUT terminals, and to digital equipment (CD player, MD player, DAT, etc.) through the DIGITAL OPTICAL IN/OUT terminals.
Before making connections, turn off all the components.

ANALOG IN / OUT terminals

Connect the ANALOG OUT terminals to PLAY IN terminals on an amplifier to play through speakers connected to the amplifier.
Connect the ANALOG IN terminals to the REC OUT terminals on an amplifier to record sounds from other components connected to the amplifier.

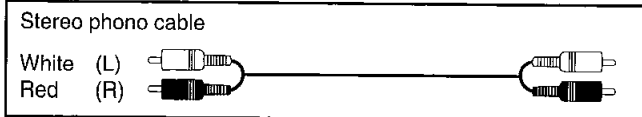

DIGITAL OPTICAL terminals

Remove the dust-protection caps (a) before connecting the optical fiber cables.
Connect IN 1 and IN 2 to OPTICAL OUT terminals on other playback components for digital recording to this unit.
Connect OUT to OPTICAL IN terminals on other recording components to record from this unit.

Note

DIGITAL OPTICAL terminals not in use should be covered by a dust protection cap.

FOR UNITED KINGDOM ONLY
BE SURE TO READ THE CAUTION FOR THE AC MAINS LEAD ON PAGE 3 BEFORE CONNECTION.

AC IN terminal

Connect to a household mains socket (b) with the AC mains lead.

Insertion of Connector

Even when the connector is perfectly inserted, depending on the type of inlet used, the front part of the connector may jut out as shown in the drawing. However there is no problem using the unit.

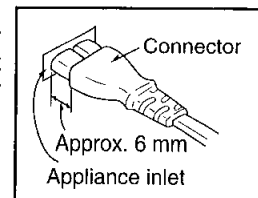

Note

This unit may interfere with radio reception so leave some distance between it and your tuner.

Before use

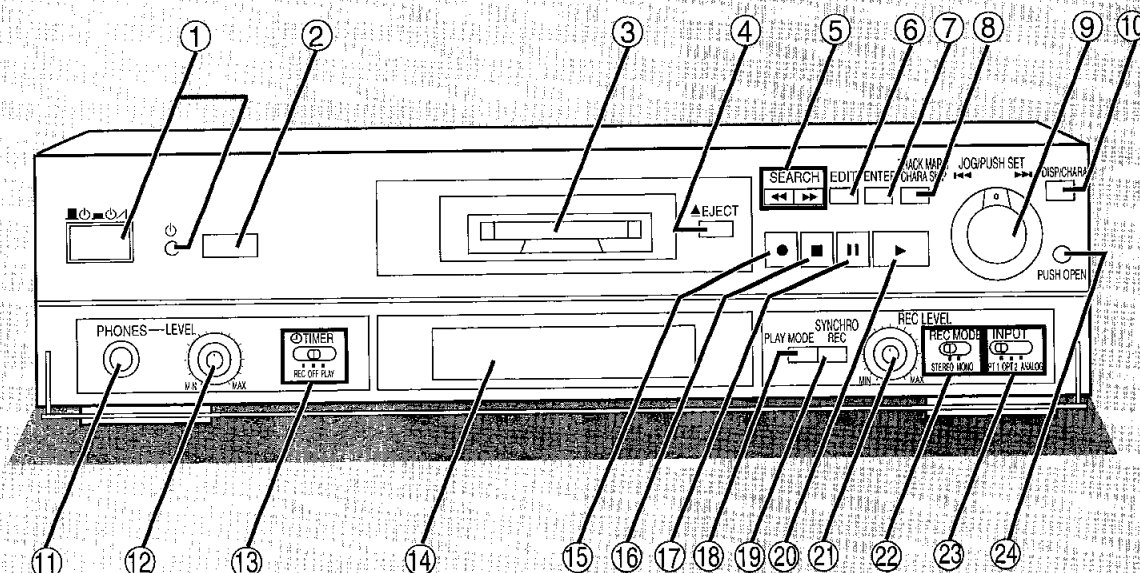

No.	Name	Ref. page
①	Unit on/off button (■ ⏻ ■ ⏻ /I) and remote standby indicator (⏻)	8, 10
	Use this button to turn the unit on and off.	
	■ (off): The unit is in standby mode.	
	■ (on): The unit is on. The unit can be turned on and off with the remote control. When the unit is turned off with the remote control it is in remote standby and the indicator lights.	
	The unit is still using a small amount of power in the standby and remote standby conditions. Standby uses less power.	
②	Remote control signal sensor	7
③	MD slot	8, 10
④	Eject button (▲ EJECT)	9, 10
⑤	Search buttons (◀◀, ▶▶ SEARCH)	10
⑥	Editing mode button (EDIT)	16
⑦	Enter button used in editing (ENTER)	16
⑧	Track mark mode select / Character skip button (TRACK MARK / CHARA SKIP)	8, 16
⑨	JOG/skip dial (JOG/PUSH SET ◀◀, ▶▶)	10, 11

No.	Name	Ref. page
⑩	Display mode select / Character select button (DISP/CHARA)	15, 16
⑪	Headphones jack (PHONES)	15
⑫	Headphones level control (LEVEL)	15
⑬	Timer selector (⌚ TIMER)	23
⑭	Display	
⑮	Record button (●)	8, 15
⑯	Stop button (■)	8, 10
⑰	Pause button (⏸)	9, 10
⑱	Playback mode selector (PLAY MODE)	12, 13
⑲	Synchro-record button (SYNCHRO REC)	11
⑳	Playback/recording start button (▶)	8, 10
㉑	Recording level control (REC LEVEL)	9
㉒	Recording mode selector (REC MODE)	8
㉓	Input selector (INPUT)	8
㉔	Panel open button (PUSH OPEN)	
	Press this button to open the transparent panel.	
	Close the panel by hand.	

Note

The transparent panel is open in all explanations in this manual.

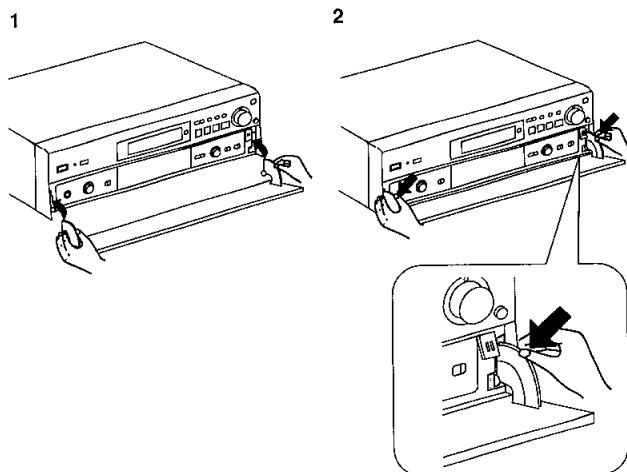

If the transparent panel comes off

1. Insert the panel as shown in the illustration.
 2. Ensure the panel is parallel to the unit, then press firmly down and in on the levers until they click into place.
 3. Check that the panel now moves correctly.
- If it does not, remove it and repeat the above procedure.



The remote control

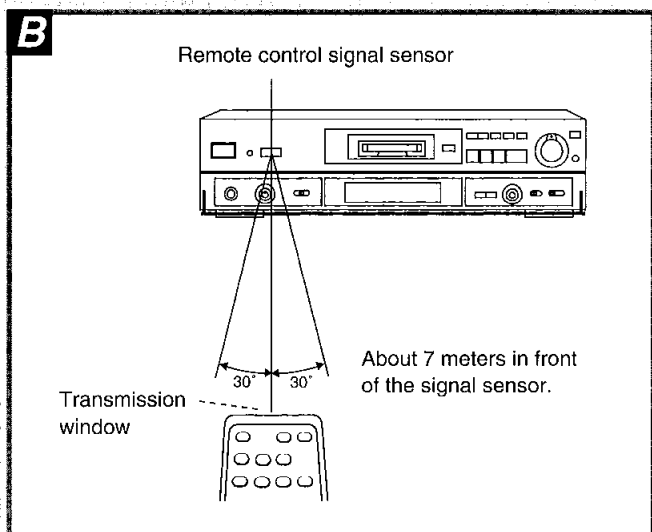
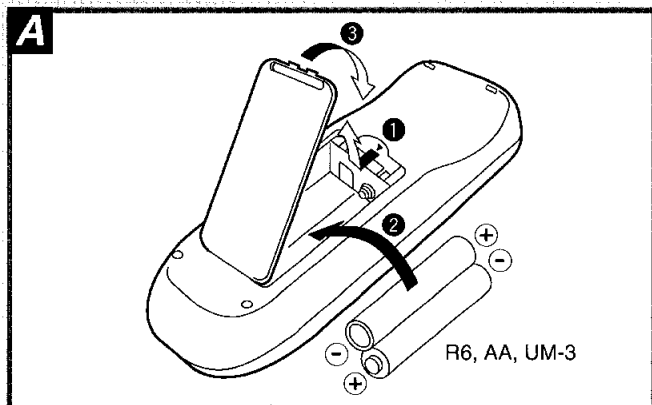
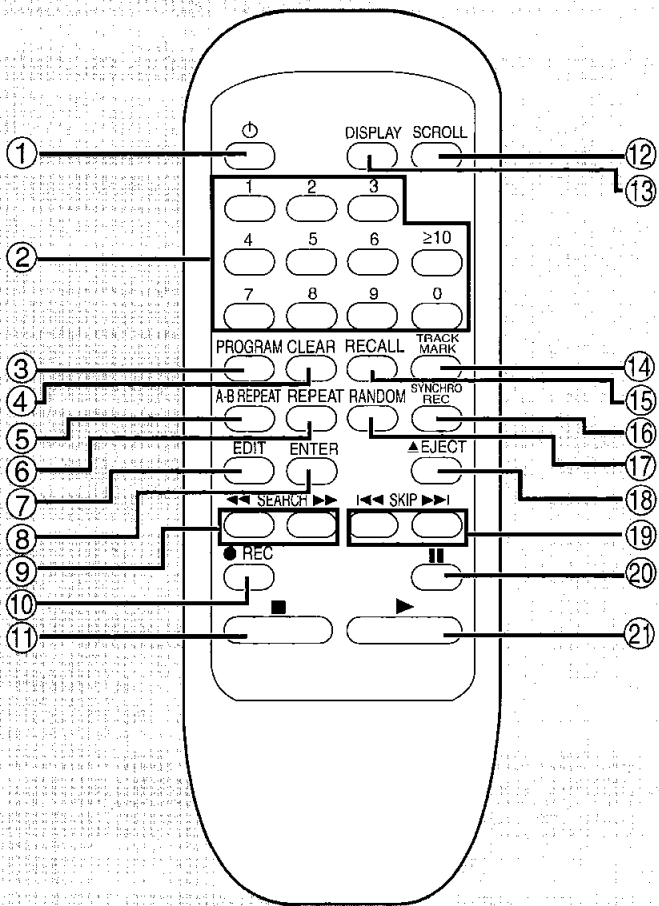

No.	Name	Ref. page
①	Unit on/off button ()	8, 10
	Use this button to turn the unit on and off when the unit's [/I] button is on ().	
②	Numeric buttons (1-0, ≥10)	12
③	Program button (PROGRAM)	13
④	Program clear button (CLEAR)	13
⑤	A-B repeat button (A-B REPEAT)	14
⑥	Repeat button (REPEAT)	14
⑦	Editing mode button (EDIT)	20
⑧	Enter button used in editing (ENTER)	20
⑨	Search buttons (SEARCH)	10
⑩	Record button (REC)	8, 15
⑪	Stop button ()	8, 10
⑫	Scroll button (SCROLL)	15
⑬	Display select button (DISPLAY)	15
⑭	Track mark select button (TRACK MARK)	8
⑮	Recall button (RECALL)	13
⑯	Synchro-record button (SYNCHRO REC)	11
⑰	Random play button (RANDOM)	12
⑱	Eject button (EJECT)	9, 10
⑲	Skip buttons (SKIP)	10
⑳	Pause button ()	9, 10
㉑	Playback/recording start button ()	8, 10

Battery installation

Insert the batteries observing the correct polarities (+, -)

- Do not mix old and new batteries, or batteries of different types (carbon and alkaline, etc.).
- Never subject batteries to excessive heat or flame; do not attempt to disassemble them; and be sure they are not short-circuited.
- If the remote control is not to be used for a long period of time, remove the batteries and store them in a cool, dark place.
- Do not attempt to recharge alkaline or carbon batteries.
- Do not use batteries if the covering has been peeled off.
- Do not use rechargeable type batteries.

Mishandling of batteries can cause electrolyte leakage which can damage items the fluid contacts and may cause a fire.

If electrolyte leaks from the batteries, consult your dealer.

Wash thoroughly with water if electrolyte comes in contact with any part of your body.

Correct method for use

Operation notes

- Do not place obstacles between the remote control signal sensor and remote control unit.
- Do not expose the remote control signal sensor to direct sunlight or to the bright light of a fluorescent light.
- Keep the remote control unit and the remote control signal sensor clean.
- If this system is installed in a rack with glass doors, the glass doors' thickness or color might make it necessary to use the remote control a shorter distance from the system.

To prevent damage

- Never place heavy items on top of the unit.
- Do not disassemble or reconstruct the unit.
- Do not spill water or other liquids into the unit.

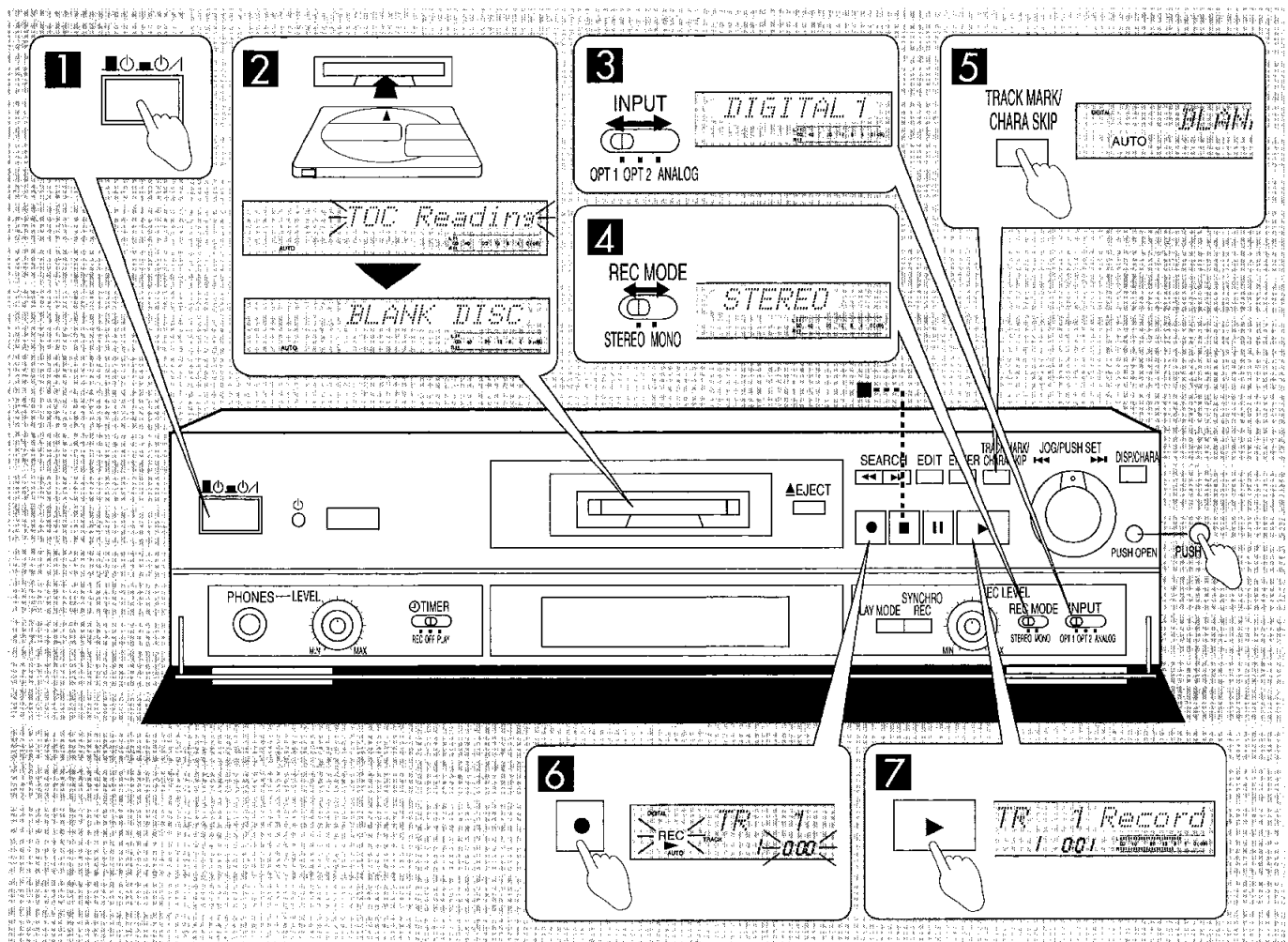

If you are using MDs for the first time, refer to the explanations on page 26 for clarification of the terms used.

Before operation

Turn on the unit you are recording from and prepare it for play.

- 1** Press [].
The unit comes on.
- 2** Insert the MD for recording.
The MD is pulled into the unit after it is pushed in part of the way.
The message "TOC Reading" flashes on the display and then any text information about the disc is shown.
- 3** Select the input terminals to be used with [INPUT].
OPT 1: When using DIGITAL OPTICAL IN 1 terminal
OPT 2: When using DIGITAL OPTICAL IN 2 terminal
ANALOG: When using ANALOG IN terminal
- 4** Select the recording mode with [REC MODE].
STEREO: This is the normal recording mode.
MONO: Twice the amount of material can be recorded in this mode compared to the STEREO mode.
- 5** Select the marking mode with [TRACK MARK/CHARA SKIP].
Each time the button is pressed: AUTO ↔ off
AUTO: Track marks are automatically inserted (→ see page 9).
Off: If track marks are unnecessary or when you want to insert them manually (→ see page 11).
- 6** Press [].
The unit goes to recording standby.
If you selected ANALOG in step 3:
Adjust the recording level. (→ See page 9 for details.)
- 7** Press [] to start recording and start play back of the sound source.

To stop recording

Press [].
Recording has finished when the message "UTOC Writing" disappears from the display.

Note

- The recording and marking modes and the input source cannot be changed while recording.
- Do not turn the unit off or eject the disc while "UTOC Writing" is still on the display.
This can cause the recording to be erased and damage to the disc.

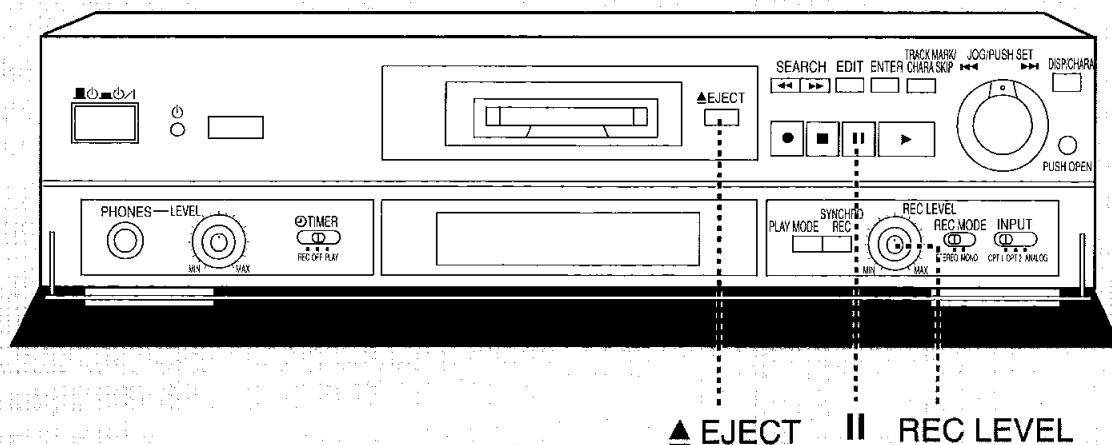

To pause recording

Press [II].

A track mark is added if the marking mode has been set to AUTO. Press again to resume recording.

To eject the MD

Press [▲ EJECT].

Note

Recording starts from where the last recording ended so it is not necessary to look for a blank section. You cannot record over tracks. If a track is no longer required and you need to make space on the disc, use the editing functions.

Your attention is drawn to the fact that recording pre-recorded tapes or discs or other published or broadcast material may infringe copyright laws.

Digital recording (➔ See step 3 on page 8)

Input through OPT 1 or OPT 2 will result in digital recording. This unit has a sampling rate converter. This enables you to record sound from satellite and cable tuners (32 kHz and 48 kHz). The message "DIGITAL IN UNLOCK" is displayed if the source equipment is not connected correctly or it isn't on. The number of times you can record and re-record digital material is limited (➔ see page 26). Recording level adjustments are made automatically.

Auto tracking (➔ See step 5 on page 8)

When set to AUTO, track marks are inserted as they are received from a digital source, or after three seconds of silence when analogue recording.

Track marks may not be inserted correctly while analogue recording in the following cases:

- If the space between tracks is short;
 - If there is noise between tracks;
 - If there are parts of the track that play at an extremely low level;
 - If recording is started partway through a track (the first silent section after recording begins is not registered).
- Use the editing functions after recording is finished to correct the track marks.

How to adjust the recording level

Necessary when recording is analogue

- ① Playback the source to be recorded.
- ② Turn [REC LEVEL] to select the right level. Set the dial so that highest level on the source pushes the peak level meters just up to 0 dB. (A red indicator lights if the level is too high.)

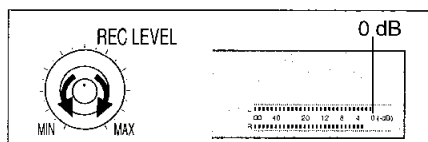

- ③ Stop the source. Now begin recording (➔ see step 7 on page 8)

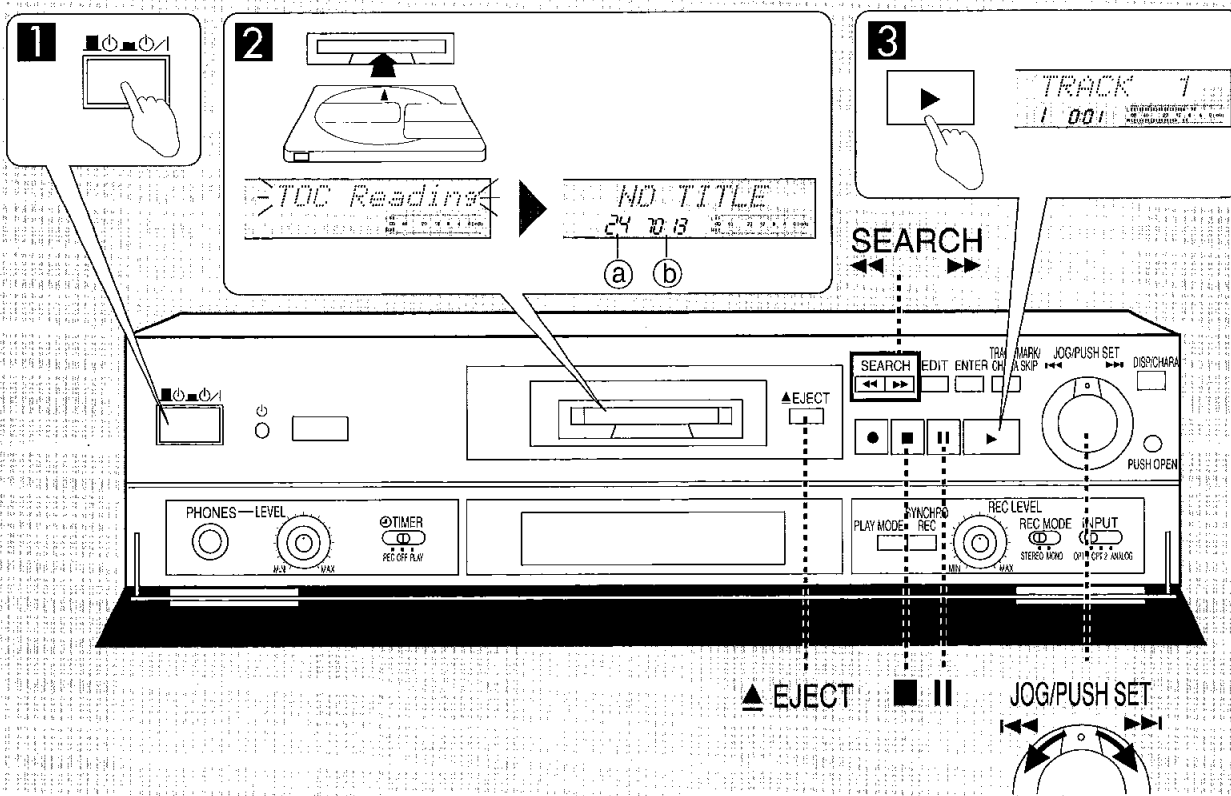

If you are using MDs for the first time, refer to the explanations on page 26 for clarification of the terms used.

- 1** Press [].
The unit comes on.
- 2** Insert the MD.
The MD is pulled into the unit after it is pushed in part of the way.
The message "TOC Reading" flashes on the display and then any text information about the disc is shown.
 (a) Total number of tracks
 (b) Total play time
- 3** Press [].

To skip tracks	JOG/PUSH SET	
	backward	forward
To find a specific point	SEARCH	
	backward	forward

The disc is played at high speed until the button is released.

To stop play

Press [].

To pause play

Press [].

Press again to resume play.

To eject the MD

Press [EJECT].

Reference

The unit automatically plays stereo and monaural MDs.

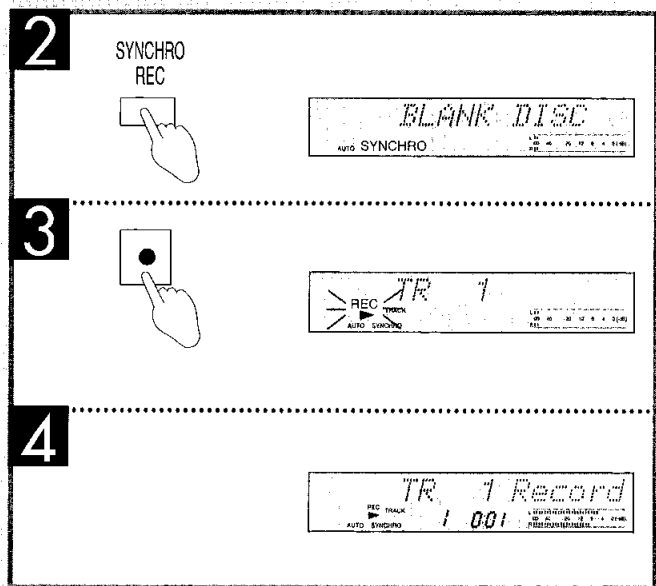
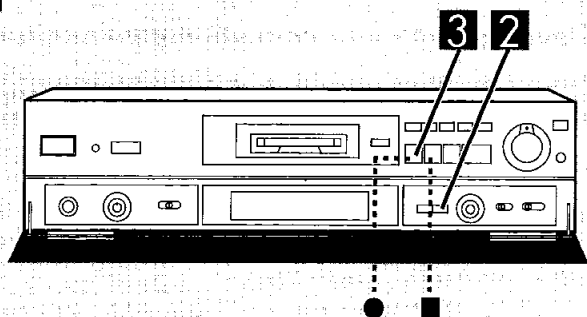
A

Functions to assist recording

Synchronized recording

A

Recording starts as soon as sound input is detected.

- 1** Insert an MD, select the source, recording and marking modes (→ steps 1 to 5 on page 8).
If you have selected analogue input, press [●], adjust the recording level and press [■].
- 2** Press [SYNCHRO REC].
"SYNCHRO" appears on the display.
- 3** Press [●].
The unit goes to recording standby.
- 4** Start playback of the source.
Recording starts as soon as sound is detected.

To stop recording

Press [■].
Recording has finished when the message "UTOC Writing" disappears from the display.

To pause recording

Pause or stop the sound source and this unit pauses after 4 seconds of silence. Recording resumes when the source is stated again. [■] on this unit doesn't work while this function is on.

This unit is paused when playback is finished.
Press [■] to cancel the function.

Note

Recording quality can be affected if a track begins with extremely low volume or if there are almost silent parts during the track. Do not use this function if the source you are recording contains such tracks. (Track marks can be added with the editing function after recording.)

Adding track marks during recording

B

Add track marks where you want.

During recording
Press [JOG/PUSH SET].

A track mark is added each time the button is pressed and the number of tracks increases.

Reference

Up to 254 track marks can be inserted.

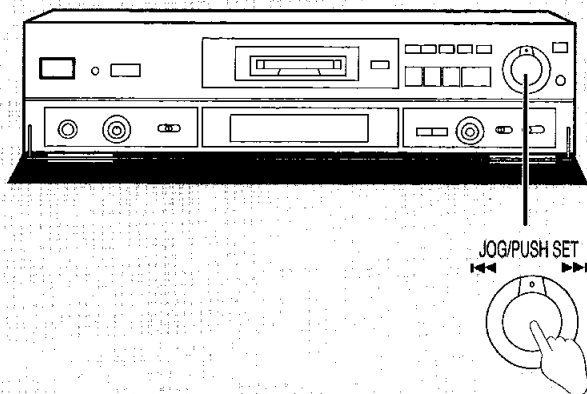
B

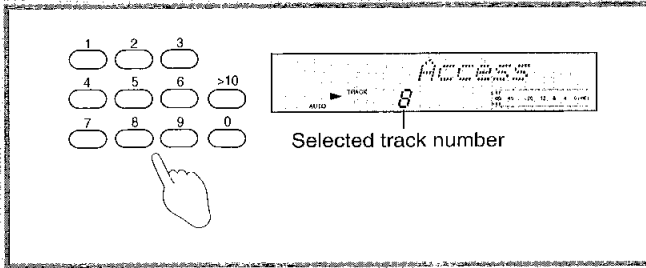
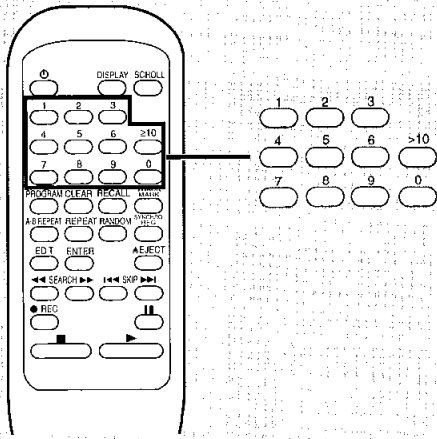
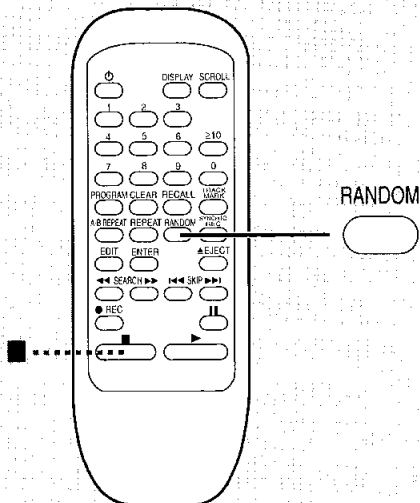
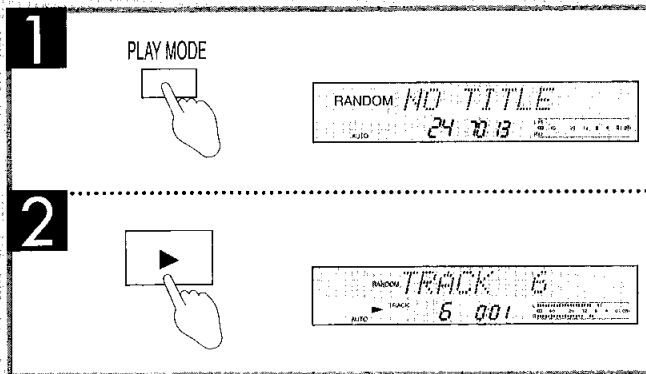
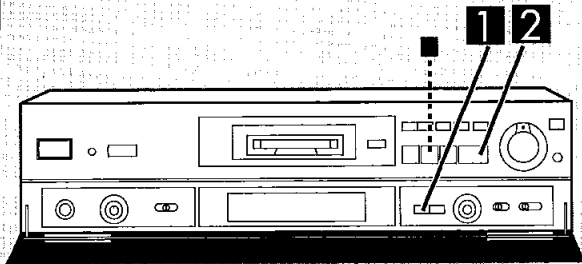
A**B**

Other playback modes

Direct play (remote control only)

A

Enter a number to play a track.

Either while stopped or during play

Press the numeric buttons.

The selected track starts playing.
Play then continues to the final track.

To select a track numbered 1 to 9

Press the corresponding numeric button.

To select a two digit number (10 to 99)

First press [≥ 10] then the corresponding numeric buttons.

e.g. Track 10: [≥ 10] → [1] → [0]

To select a three digit number (100 to 254)

First press [≥ 10] twice then the corresponding numeric buttons.

e.g. Track 235: [≥ 10] → [≥ 10] → [2] → [3] → [5]

Random play

B

Randomly plays all the tracks on the MD.

On the main unit

While stopped

- 1 Press [PLAY MODE] so "RANDOM" appears on the display.

Each time the button is pressed: PRGM → RANDOM → off

- 2 Press [▶].

All tracks play once each in random order.

On the remote control

While stopped

Press [RANDOM].

Random play begins immediately.

To cancel random play

Press [■]. (Press twice if the unit is playing.)

"RANDOM" is cleared.

Note

During random play, you cannot skip back to tracks that have been played, or search backward or forward between tracks.

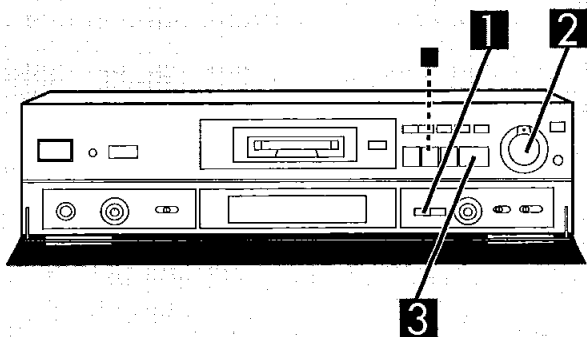

Program play

This function allows you to playback up to 24 tracks in a selected order.

On the main unit

While stopped

1 Press [PLAY MODE] so "PRGM" appears on the display.
Each time the button is pressed: PRGM → RANDOM → off

2 Turn [JOG/PUSH SET] then press when the required track number appears on the display.
Repeat this step to program all the required tracks in order.

"FULL" appears on the display when there is no space left in the program.

3 Press [▶].
The selected program begins.
• The program remains intact even if the unit is turned off and on again.

On the remote control

While stopped

- ① Press [PROGRAM].
- ② Select the tracks in the required order with the numeric buttons (→ see page 12 for details).
- ③ Press [▶].

To cancel program play

Press [■]. (Press twice if the unit is playing.)

"CLEAR" appears on the display for a second and "PRGM" is cleared.

The programmed contents are also cleared.

To check the contents of the program (remote control only)

Press [RECALL].

A track number and its order in the program are displayed each time you press the button.

To clear particular tracks from the program (remote control only)

1. Press [RECALL] successively until the track to be cleared appears on the display.
2. Press [CLEAR] while "RECALL" is on the display.
"CLEAR" appears on the display and the track is removed from the program.

It is not necessary to press [RECALL] if you want to clear the last track from the program. The last track is removed each time [CLEAR] is pressed.

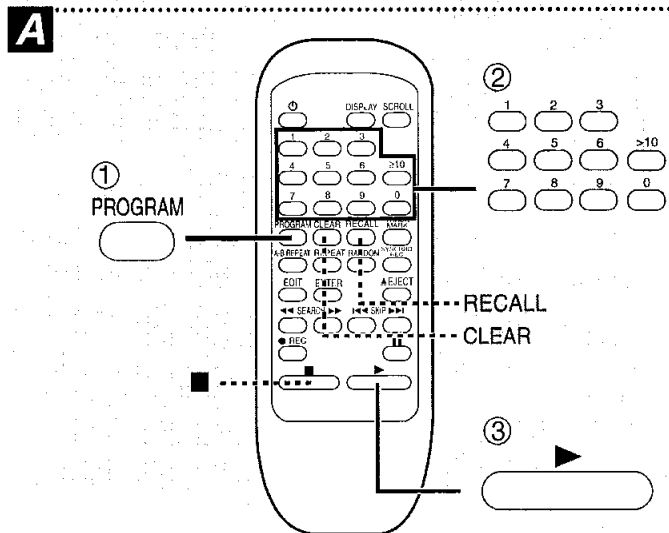
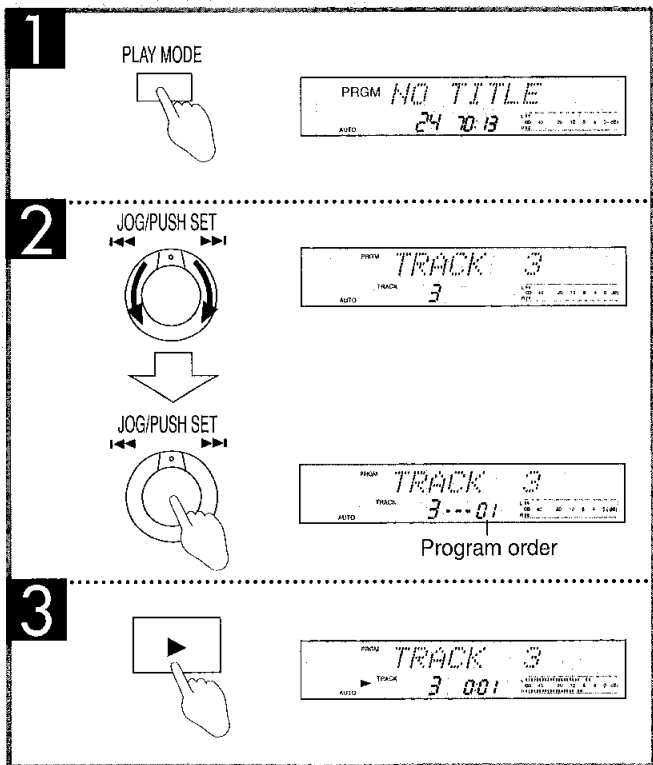

A

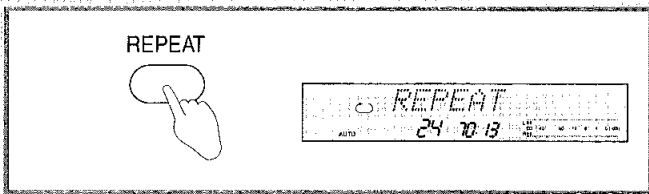
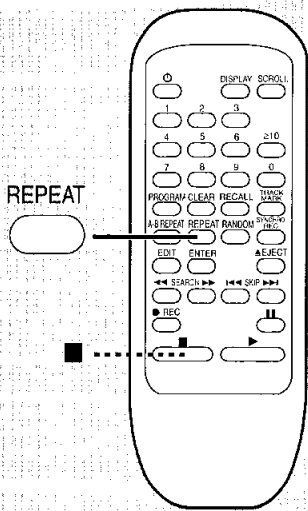

B

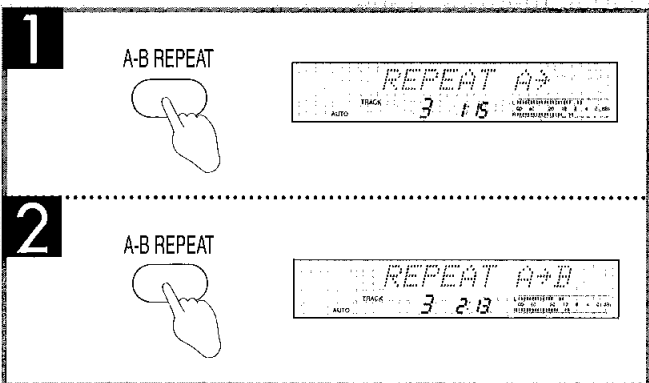
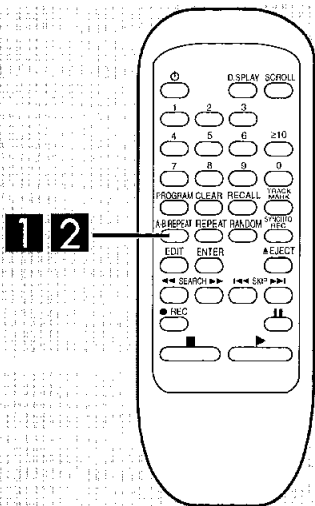

Other playback modes

Repeat play (remote control only)

Repeating one or all of the tracks A

Press [REPEAT] so either "⏮" or "1-⏮" appears on the display.

Each time the button is pressed: ⏮ → 1-⏮ → off

⏮ : all tracks played repeatedly

This mode also functions during random and program play. Press [REPEAT] so "⏮" appears on the display before or after play is started.

1-⏮ : one track played repeatedly

If activated during play, the current track is played repeatedly. If activated before play, the first track is played repeatedly after play starts.

Select another track by skipping or selecting it directly with the numeric buttons.

Canceling repeat play

Press [■]. (Press twice if unit is playing.)

The mode is also cleared if [REPEAT] is pressed to clear "⏮" or "1-⏮" from the display.

Repeating a particular section - A-B repeat B

During play

1 Press [A-B REPEAT] at the point repeating is to start.

2 Press [A-B REPEAT] again at the point repeating is to finish.
The chosen section plays repeatedly.

To cancel A-B repeat

Press [A-B REPEAT].

It is also cleared if play is stopped.

Note

A-B repeat does not work with random, program or repeat play.

Changing the display

Press [DISP/CHARA].

Different information appears on the display each time the button is pressed. The information shown depends on the condition of the unit.

Example

During play

- ① Name of track and elapsed time
- ② Track number and remaining time

While recording

- ① Track number and elapsed time for that track
- ② Remaining time on MD

While stopped

- ① Title of disc, total number of tracks and total play time of the disc
- ② Remaining available time on the disc

Reference

Text over 12 letters long scrolls whenever that display is returned to.

Scrolling the display (remote control only)

When the title of a disc or the names of tracks are too long to fit on the display at one time, the unit automatically scrolls that information across the screen once when the information is first accessed. This operation allows you to see the information in full again.

While the disc title or track name are being displayed

Press [SCROLL].

The information scrolls from right to left across the display.

Using headphones

- ① Plug the headphones (not included) into the [PHONES] jack. Plug type: 6.3 mm stereo
- ② Turn [LEVEL] to adjust the volume.

Note

Avoid listening for prolonged periods of time to prevent hearing damage.

Monitor function

Input from units connected to this unit's input terminals can be sent to units connected to this unit's output terminals.

The signal is output through the OPTICAL OUT and ANALOG OUT terminals. This unit converts digital and analogue signals automatically so you can, for example, send digital input directly to an analogue amplifier.

- ① Press [▲ EJECT] if an MD is in the unit. (This function will not work if an MD is in the unit.)
- ② Press [●]. ("Monitor" appears on the display.)
- ③ Select the source with [INPUT].
Begin play on the selected source and the sound is output automatically.
Press [■] to cancel.

A

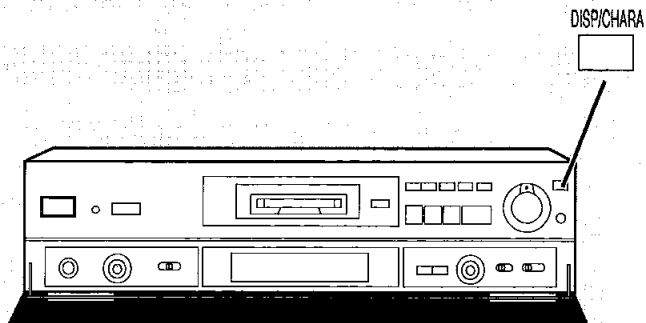

B

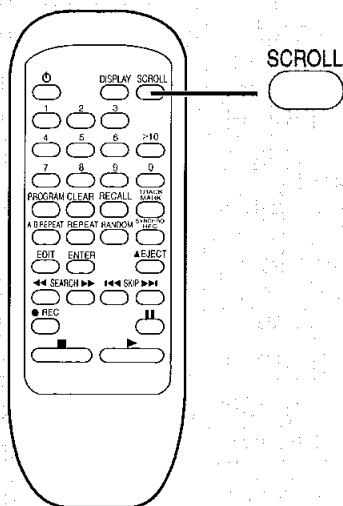

C

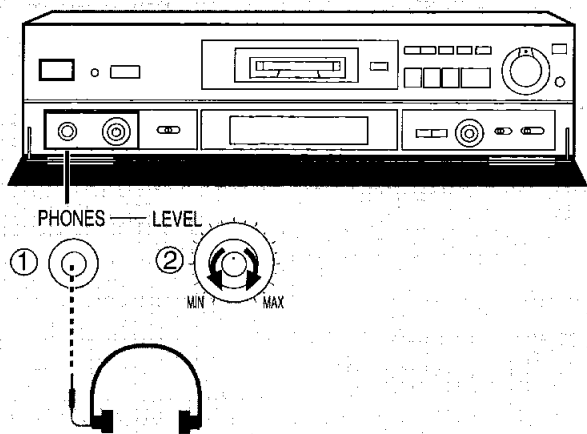

D

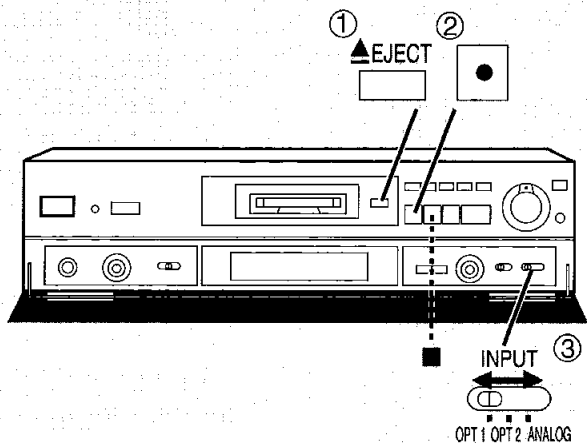

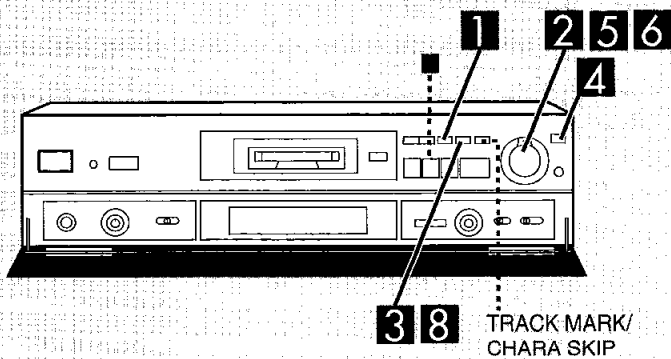

3 8 TRACK MARK/
CHARA SKIP

1		
2		<p>Selected track number</p>
3		
4		
5		
6		<p>Number of letters</p>
8		

Titling tracks and discs

Each title can have up to 100 letters. A single MD can hold about 1700 letters worth of text information. You can not add titles to prerecorded MDs.

Make sure the disc is record enabled.

While stopped

- 1** Press [EDIT] to select "TRACK TITLE?" or "DISC TITLE?".
Each time the button is pressed: TRACK TITLE? → DISC TITLE? → MOVE? → COMBINE? → TRACK ERASE? → ALL ERASE? → current display
- 2** If you selected "TRACK TITLE?"
Turn [JOG/PUSH SET] to select the track.
- 3** Press [ENTER].
The text input mode is activated.
- 4** Press [DISP/CHARA] to select the kind of text.
Each time the button is pressed: CAPITALS/symbols → lower case/symbols → Numerals
- 5** Turn [JOG/PUSH SET] to select the letter (a).
Five letters are shown on the right hand side of the display at one time. Turn [JOG/PUSH SET] or press [TRACK MARK/CHARA SKIP] to show the next group of five letters.
- 6** Press [JOG/PUSH SET].
The selected letter is now shown on the left hand side of the display and the cursor marks the place where the next character will go.
- 7** Repeat steps 4, 5 and 6 to complete the title.
(→ Page 17 has more information about entering text.)
- 8** Press [ENTER].
"UTOC Writing" appears on the display. When this message disappears the title has been entered.

Stopping part way through

After step 1 or 2: Press [■].
After steps 3 to 7: Press [EDIT] then [■].

Note

These cannot be selected with [EDIT] on the remote control.

continued page 17

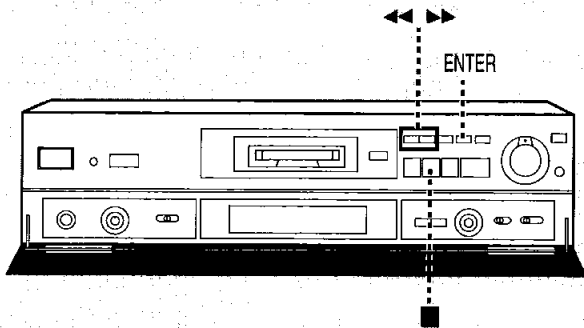

Characters available for titles

Text mode	Character (○: space)
CAPITALS / symbols	ABCDE FGHIJ KLMNO PQRST UVWXY Z ○ ! " # \$ % & ' () * + , - . / : ; < = > ? @ _ `
lower case / symbols	abcde fg hij klmno pqrst uvwxy z ○ ! " # \$ % & ' () * + , - . / : ; < = > ? @ _ `
Numerals	0 1 2 3 4 5 6 7 8 9

Editing text

Press [◀◀] or [▶▶] to move the cursor.

Erasing letters

Move the cursor so it covers the letter to be erased and press [■]. The letter is erased and the other letters move to fill the space.

Inserting a letter or space

Move the cursor to the letter to the right of the place where the new letter or space is to go. Now select and enter the new letter with [JOG/PUSH SET].

Changing letters

- ① Erase the old letter.
- ② Insert the new letter.

Making corrections to a title

- ① Select the title to be corrected (➔ steps 1 to 3 on page 16).
- ② Use the above editing techniques to correct the title.
- ③ Press [ENTER].

continued page 18

A

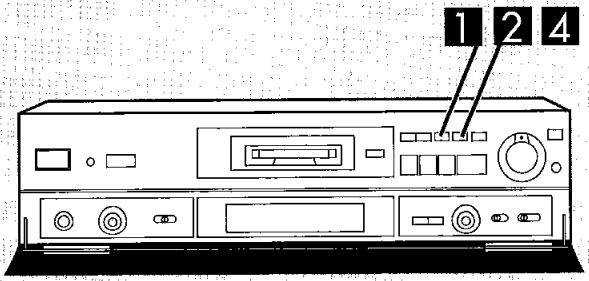

1 **EDIT**
 TRACK TITLE?
 1 0 1 3

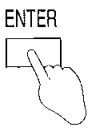
2 **ENTER**
 ABCDE
 1 P 1 3

4 **ENTER**
 Moonlight
 1 2 3 1

B

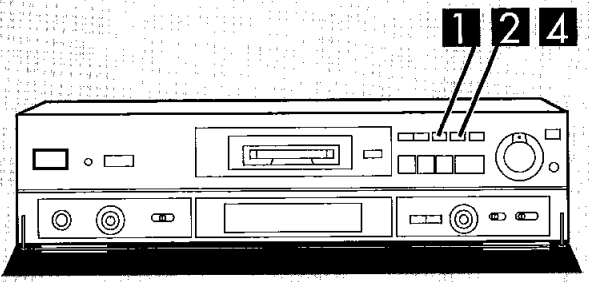

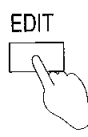
1 **EDIT**
 TRACK TITLE?
 1 0 1 3

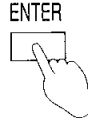
2 **ENTER**
 ABCDE
 1 P 1 3

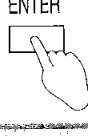
4 **ENTER**
 Moonlight
 1 2 3 1

Editing MDs

Titling a track being recorded **A**

While recording is in process

- 1** Press [EDIT].
"TRACK TITLE?" appears on the screen.
- 2** Press [ENTER].
- 3** Enter the title (⇒ steps 4 to 7 on page 16).
This can be continued even if the track changes during recording.
- 4** Press [ENTER].
The previous display is restored and the title is displayed.

The title is entered after recording finishes and "UTOC Writing" disappears from the display.

To cancel part way through

Press [EDIT] until the normal display is restored.

Titling a track being played **B**

While track is playing

- 1** Press [EDIT] to select "TRACK TITLE?".
Each time the button is pressed: TRACK TITLE? → DIVIDE? → MOVE? → COMBINE? → TRACK ERASE? → current display
- 2** Press [ENTER].
- 3** Enter the title (⇒ steps 4 to 7 on page 16).
The track is played repeatedly.
- 4** Press [ENTER].
The previous display is restored and the title is displayed.

The title is entered after play stops and "UTOC Writing" disappears from the display.

To cancel part way through

Press [EDIT] until the normal display is restored.

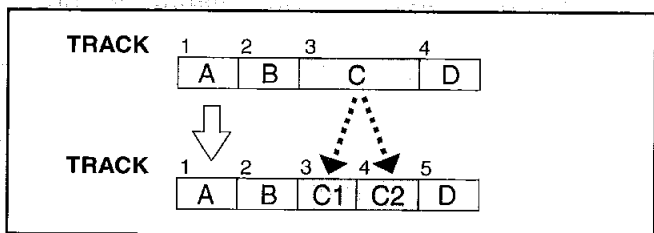
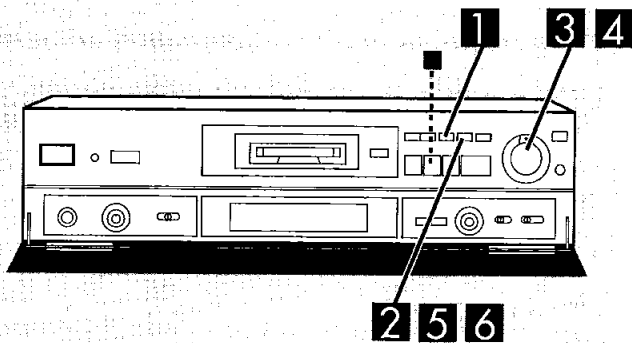

1

2

3

4

5

6

Dividing tracks - DIVIDE

This function allows you to manually add track marks. This means you can edit a radio program you recorded, or divide a symphony into its separate movements.

Make sure the disc is record enabled.

While the track you want to divide is playing

- 1** Press [EDIT] to select "DIVIDE?".
Each time the button is pressed: TRACK TITLE? → DIVIDE?
→ MOVE? → COMBINE? → TRACK ERASE? → current display
- 2** Press [ENTER].
If the point you want to put the track mark at has already gone past, turn [JOG/PUSH SET] to return to the beginning of the track. You can also select a different track at this point.
- 3** At the point you want to add the track mark. Press [JOG/PUSH SET].
A 4-second segment of the track, beginning at the selected point, is played repeatedly (8 seconds if the track was recorded in MONO mode).
- 4** Turn [JOG/PUSH SET] adjust the point.
Adjustment can be made between -128 and +127, approximately 8 seconds either side of the original point (16 seconds if the track was recorded in MONO mode).
- 5** Press [ENTER].
"DIVIDE OK?" appears on the display. If you wish to cancel press [■] now.
- 6** Press [ENTER].
"UTOC Writing" appears on the display. When this message disappears the track mark has been entered. Play stops.

Stopping part way through

Press [■].

To remove the dividing track mark

Use COMBINE (→ see page 21).

Note

- If a titled track is divided, the latter half becomes untitled. There is no interruption to sound even if a track mark is added.
- This cannot be selected with [EDIT] on the remote control.

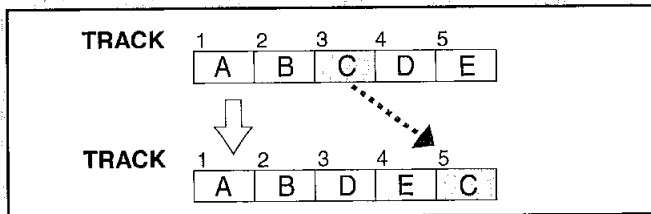
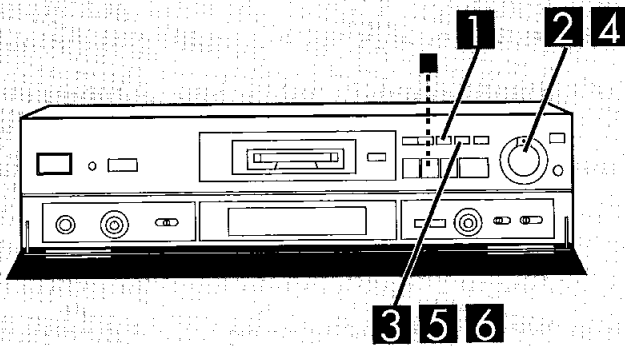

1	EDIT		
2	JOG/PUSH SET		 Selected track number
3	ENTER		
4	JOG/PUSH SET		 New track number
5	ENTER		
6	ENTER		

Moving tracks - MOVE

This function allows you to permanently change the order tracks are played in.

Make sure the disc is record enabled.

While stopped

- 1** Press [EDIT] to select "MOVE?".
Each time the button is pressed: TRACK TITLE? → DISC TITLE? → MOVE? → COMBINE? → TRACK ERASE? → ALL ERASE? → current display
- 2** Turn [JOG/PUSH SET] select the track to be moved.
- 3** Press [ENTER].
- 4** Turn [JOG/PUSH SET] select the position (track number) the track is to be moved to.
To move the track to position 5, track number "5" should be on the display.
- 5** Press [ENTER].
A message confirming your selection appears on the display. If you wish to cancel press [■] now.
- 6** Press [ENTER].
The move is confirmed after "UTOC Writing" disappears from the display.

To move a track while it is being played

This is useful when you want to make sure of the track you are moving.

While playing the track to be moved.

- ① Press [EDIT] to select "MOVE?".
Each time the button is pressed: TRACK TITLE? → DIVIDE? → MOVE? → COMBINE? → TRACK ERASE? → current display
- ② Press [ENTER].
- ③ Turn [JOG/PUSH SET] select the position (track number) the track is to be moved to.
- ④ Press [ENTER] twice.
The move is confirmed after "UTOC Writing" disappears from the display and play stops.

To cancel part way through

Press [■].

To return the track to its original position

Repeat the above steps, selecting the track's original position in step 4.

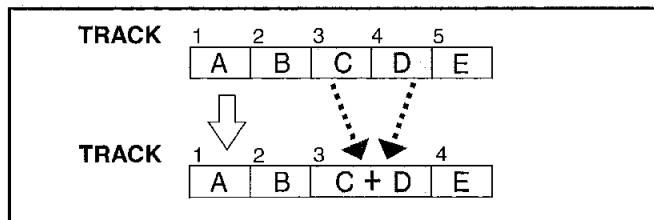
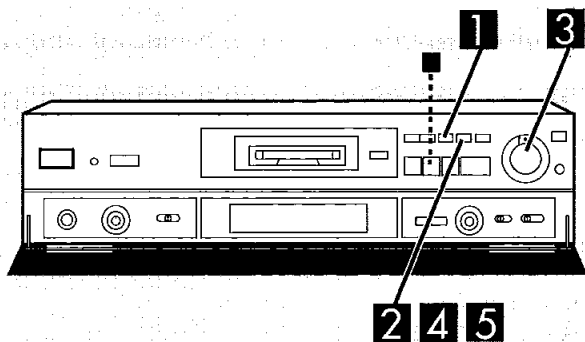

1 EDIT

2 ENTER

3 JOG/PUSH SET

4 ENTER

5 ENTER

Combining tracks - COMBINE

This function removes a track mark so the two tracks either side of it effectively become one track. This is useful to remove track marks that were unnecessarily added during recording.

Make sure the disc is record enabled.

While stopped

- 1** Press [EDIT] to select "COMBINE?".
Each time the button is pressed: TRACK TITLE? → DISC TITLE? → MOVE? → COMBINE? → TRACK ERASE? → ALL ERASE? → current display
- 2** Press [ENTER].
- 3** Turn [JOG/PUSH SET] select the two tracks to be combined.
- 4** Press [ENTER].
A message confirming your selection appears on the display. If you wish to cancel press [■] now.
- 5** Press [ENTER].
"UTOC Writing" appears on the display. When this message disappears the track mark has been erased.

Combining tracks during play

This is useful to confirm the tracks you want to combine.

While playing the latter track

- ① Press [EDIT] to select "COMBINE?".
Each time the button is pressed: TRACK TITLE? → DIVIDE? → MOVE? → COMBINE? → TRACK ERASE? → current display
- ② Press [ENTER] three times.
"UTOC Writing" appears on the display. When this message disappears the track mark has been erased. Play stops.

To cancel part way through

Press [■].

To divide the tracks again

Use DIVIDE (⇒ page 19).

Note

A track recorded in stereo mode and a track recorded in mono mode cannot be combined.

If the two tracks both had titles, only the title of the first track remains after they are combined.

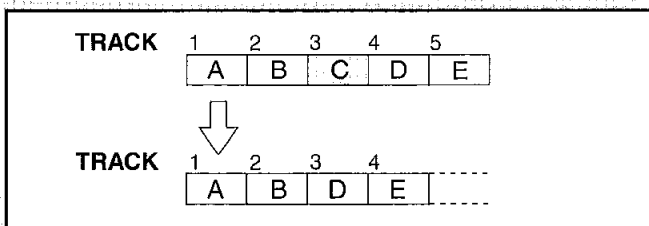
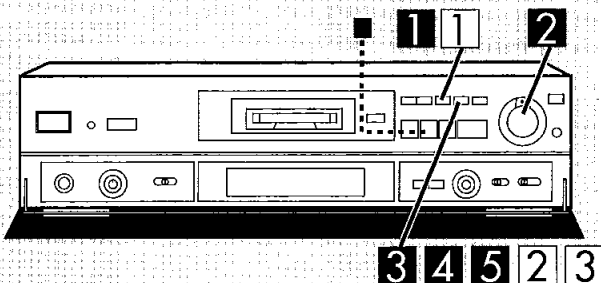

1 EDIT

2 JOG/PUSH SET

3 ENTER

Available time

4 ENTER

5 ENTER

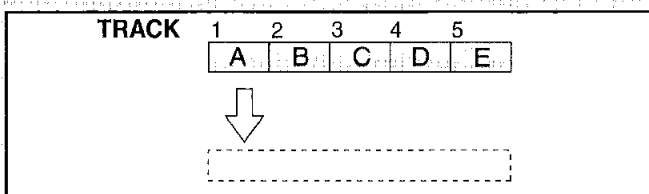

1 EDIT

2 ENTER

3 ENTER

Erasing tracks

Unneeded tracks can be erased and the available recording time can be increased.

Make sure the disc is record enabled.

While stopped

1 Press [EDIT] to select "TRACK ERASE?". Each time the button is pressed: TRACK TITLE? → DISC TITLE? → MOVE? → COMBINE? → TRACK ERASE? → ALL ERASE? → current display

2 Turn [JOG/PUSH SET] select the track to be erased.

3 Press [ENTER]. The amount of recording time available after the track is erased is shown on the display.

4 Press [ENTER]. A message confirming your selection appears on the display. If you wish to cancel press [■] now.

5 Press [ENTER]. "UTOC Writing" appears on the display. When this message disappears the track has been erased.

Erasing a track while it is being played

This is useful to check that the right track is erased.

While the track to be erased is being played.

- ① Press [EDIT] to select "TRACK ERASE?". Each time the button is pressed: TRACK TITLE? → DIVIDE? → MOVE? → COMBINE? → TRACK ERASE? → current display
- ② Press [ENTER] three times. "UTOC Writing" appears on the display. When this message disappears the track has been erased. Play stops.

To cancel part way through

Press [■].

Erasing an entire MD

This operation creates a blank disc.

Make sure the disc is record enabled.

While stopped

1 Press [EDIT] to select "ALL ERASE?". Each time the button is pressed: TRACK TITLE? → DISC TITLE? → MOVE? → COMBINE? → TRACK ERASE? → ALL ERASE? → current display

2 Press [ENTER]. A message confirming your selection appears on the display. If you wish to cancel press [■] now.

3 Press [ENTER]. "UTOC Writing" appears on the display. When this message disappears the MD has been erased.

To cancel part way through

Press [■].

Timer recording and playback

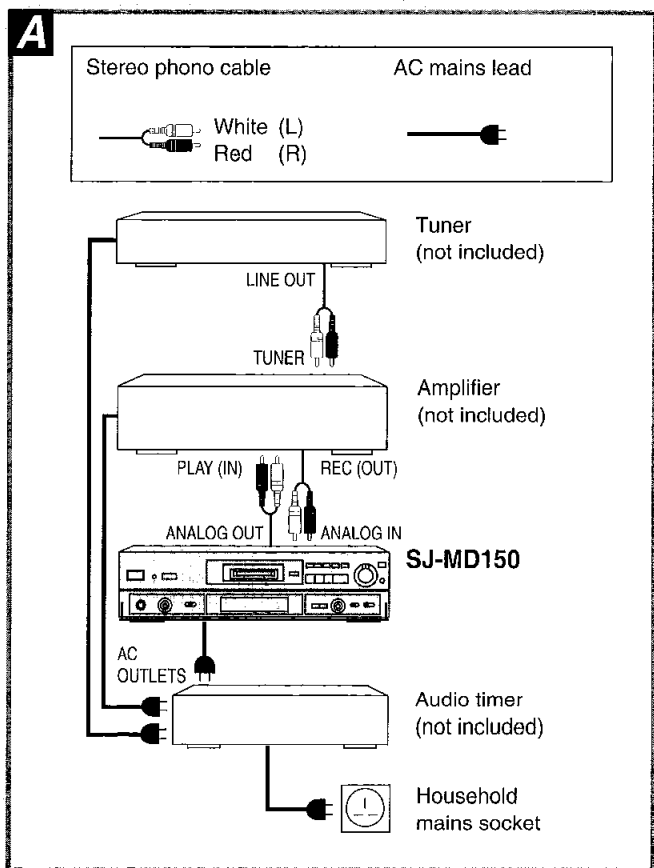

Use this unit in conjunction with an audio timer (not included) to record radio programs or start play at a selected time. The explanations refer to the connection example in the illustration. **A** See the operating instructions of the other equipment for more information.

Timer recording

First turn all the equipment on. Set the tuner and amplifier up so the radio station you want to record is played.

1 Prepare this unit for recording.

Do steps 1 to 6 on page 8 and press [■].

2 Set the timer.

The equipment connected to the timer goes off.

Set it to come on at least 30 seconds before recording is to begin and to go off at least 30 seconds after recording is to end.

3 Select "REC" with [⏸ TIMER].

This unit comes on and starts recording when the timer comes on.

Note

There will be a small delay between the timer coming on and the start of recording.

Timer playback

Turn on this unit and the amplifier and set them up so the MD you want to hear is played.

1 Insert an MD.

If you want to play particular tracks when the timer comes on, program them (→ steps 1 and 2 on page 13).

2 Set the timer.

The equipment connected to the timer goes off.

3 Select "PLAY" with [⏸ TIMER].

This unit comes on and starts playing when the timer comes on.

Note

There will be a small delay between the timer coming on and the start of play.

Important

Make sure "OFF" is selected with [⏸ TIMER] when the timer is not being used.

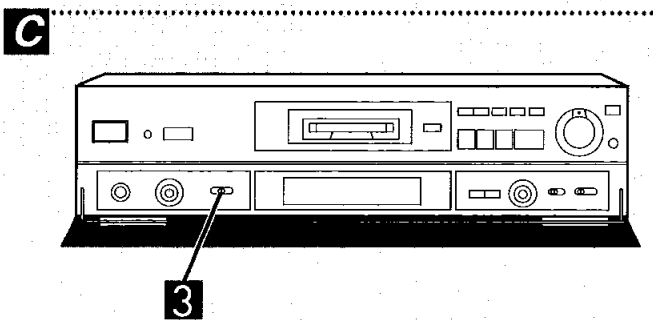
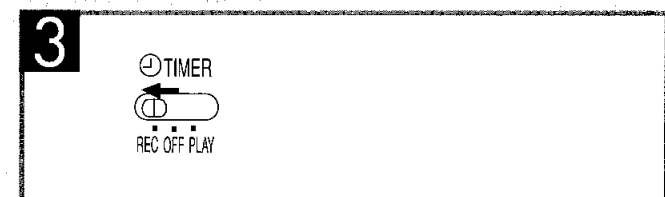
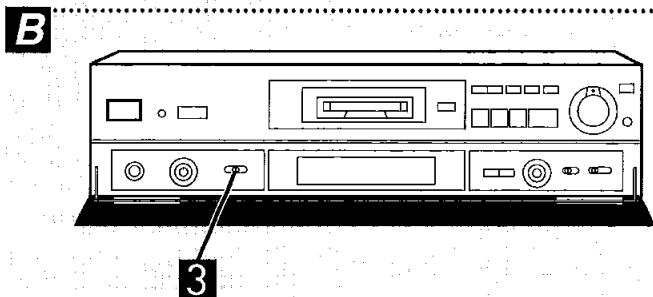

Error messages

Display	Meaning	Action
BLANK DISC	The MD you inserted has nothing recorded on it.	Unless you intend to record something, insert an MD with tracks recorded on it.
CANNOT COMBINE	You have tried to combine tracks that cannot be combined.	None. This is a limitation of the system.
CANNOT EDIT	You tried to combine track1.	Use this function on tracks numbered 2 or higher.
	You are trying to edit titles that have more than 101 letters.	You cannot edit the title on this unit. If possible, use the unit the title was originally created on to shorten the title first.
UTOO FULL	You have tried to divide a track on an MD that already has 254 tracks on it.	None. This is a limitation of the system.
	You have tried to record on an MD that already has 254 tracks on it.	Erase unneeded tracks or replace the MD.
	The title won't fit in UTOO.	Delete unnecessary titles or make the title shorter.
DIGITAL IN UNLOCK	You are trying to record from "OPT 1" or "OPT 2" but the optical cable isn't connected correctly.	Check the cable connections.
	The unit you are trying to record from hasn't been turned on.	Turn the source unit on.
DISC ERROR	The MD is damaged.	Replace it.
DISC FULL	There is no space left on the MD.	Erase unneeded tracks or replace the MD.
DISC PROTECTED	The MD is write protected.	Close the write protect switch to enable recording and editing.
EMERGENCY STOP	A problem occurred while recording.	Reinsert the MD and start again.
NO DISC	An MD hasn't been inserted.	Insert an MD.
PLAYBACK DISC	You tried to record on or edit a prerecorded MD.	Replace with a recordable MD.
SCMS CANNOT COPY	You are trying to make a copy of a recording from a digital source.	Use analogue input to make the recording.
TRACK PROTECTED	The track is protected.	The track cannot be erased. If possible, use the unit it was protected with to remove the protection. (It is possible to erase all the tracks with this unit.)
LOAD ERROR	A problem occurred while loading the MD.	Press [▲ EJECT] and try again.

Troubleshooting guide

Before requesting service for this unit, check the chart below for a possible cause of the problem you are experiencing. Some simple checks or a minor adjustment on your part may eliminate the problem and restore proper operation.

If you are in doubt about some of the check points, or if the remedies indicated in the chart do not solve the problem, refer to the directory of Authorized Service Centers (enclosed with this unit) to locate a convenient service center, or consult your Technics dealer for instructions.

Reference pages indicated in black circles. (For example : 10)

Problem	Possible cause	Action
Cannot start play.	Has an MD been inserted?	Insert an MD. 10
	Has anything been recorded on the MD?	Insert an MD with tracks recorded on it.
Cannot record.	Are you using a prerecorded MD?	Replace with a recordable MD. 26
	Is the MD write protected?	Close the write protect switch. 26
	Is there a problem with the connections?	Check all the connections. 5
	Is the recording level too low?	Turn the recording level up. 9
Cannot enter text.	Have you entered the maximum number of letters for the MD (about 1700)?	Shorten the titles on the MD. 16-17
There is time remaining on the MD and less than 254 tracks have been recorded, but recording isn't possible.	These phenomena occur from time to time and are due to the recording system used on MDs.	
Recorded time and remaining time do not add up to the total time on the MD.		

Additional information

Type of MDs

Prerecorded MDs **A**

You cannot record onto these MDs.
These MDs are called optical discs.

Recordable MDs **B**

Recording is magnetic.
These MDs are called optomagnetic discs.
Apart from the time limitations of the MD, up to 254 different tracks can be recorded on an MD.

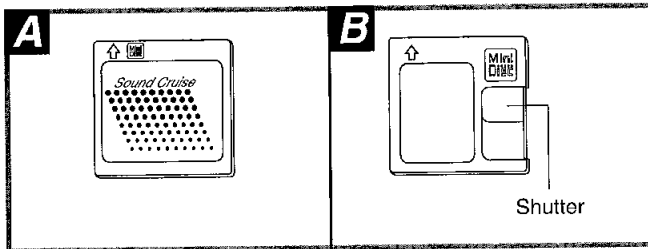

Recording and editing MDs

MDs are different to cassettes.

Recording starts from where the last recording ended so it is not necessary to look for a blank section.
When the disc becomes full, use the editing functions to erase tracks you don't want.

Preventing erasure of MDs **C**

Move the switch to open the hole.
Close the hole when you want to record or edit the MD again.

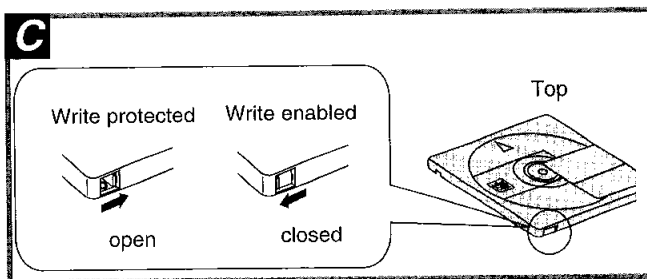

Limitations on digital recording

The serial copy management system (SCMS) prevents unlimited recording of digital material.
Recording digital sources such as CDs onto MDs through optical fiber connection allows you to make high standard recordings.
To protect the rights of the producer of the original material, it is impossible to make another digital recording of a recording.
Analogue recordings are unlimited by this system.

Glossary

Track mark

These are pieces of data on the MD that mark the boundaries of the tracks.

These marks are added automatically during recording or you can add them yourself.

Up to 254 track marks can be put on one MD.

TOC

Table of contents.

This is an area on the MD set apart from the recording area that keeps records about the tracks on the MD.

UTOC

User table of contents.

This is TOC information the user can edit.

This may include text information and results of editing operations.

The message "UTOC Writing" appears on the display whenever UTOC is being changed in some way.

MARKING

This is the action of adding track marks.

This may be done automatically during recording or the user can add track marks to the place of their choice.

Care

- Label the MD only as recommended.
Do not stick labels on the shutter.
Extra labels can catch on the mechanism and cause malfunctions. Ensure the MDs you use do not have left over adhesive on them.
- Do not open the shutter.
If it opens accidentally close it immediately.
Do not touch the disc.

Storage

Keep your MDs away from:

Direct sunlight
Humid and dusty places
Direct heat from a heating device

Maintenance

To clean this unit, wipe with a soft, dry cloth.

If the surfaces are extremely dirty, use a soft cloth dipped in a soap-and-water solution or a weak detergent solution.

- Never use alcohol, paint thinner or benzene to clean this unit.
- Before using chemically treated cloth, read the instructions that came with the cloth carefully.

Technical specifications

System	Minidisc digital audio system
Recording	Magnetic field modulation direct overwrite
Reading	Non-contact optical system with Semiconductor laser ($\lambda=780$ nm)
Sampling frequency	44.1 kHz
Coding system	ATRAC
Channel	2 channel stereo
Frequency response	5–20,000 Hz (± 0.3 dB)
SN ratio (Play)	99 dB
Dynamic range (Play)	97 dB
Wow and flutter	Below measurable limit
Input	
Analogue input (Level/Impedance)	500 mV/47 k Ω
Digital input (OPTICAL IN 1, OPTICAL IN 2)	
Wavelength	660 nm
Output	
Analogue output (Level/Impedance)	2.0 V/600 Ω
Digital output (OPTICAL)	
Rated output	-17 dBm
Wavelength	660 nm
Headphone output level	15 mW max. 32 Ω (adjustable)

■ GENERAL

Power supply	AC 230–240 V/50 Hz
Power consumption	13 W
Dimensions (W×H×D)	430×103×300 mm
Mass	3.4 kg

Note:

Specifications are subject to change without notice.
Mass and dimensions are approximate.

US and foreign patents licensed from Dolby Laboratories
Licensing Corporation.

Umweltfreundlich gedruckt auf chlorfreigebleichtem Papier.
Environment friendly printed on chlorine free bleached paper.

Matsushita Electric Industrial Co., Ltd.
Osaka 542-8588, Japan



RQT5411-B
H0200RF0 (D)